

eduard
Express Mask

F-16A Fighting Falcon

The die-cut mask for accurate canopy frame painting of the
Hasegawa 1/72 KIT

XS 217



B12
2pcs.

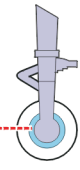
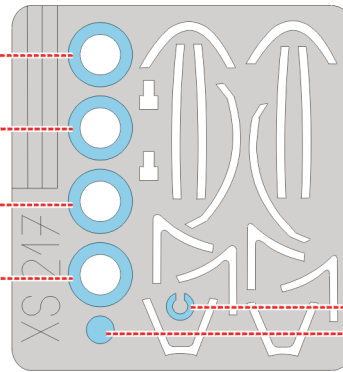
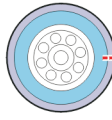

C6

B12
2pcs.

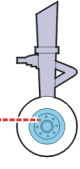
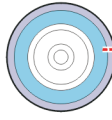

C6



LIQUID MASK ■

B12
2pcs.

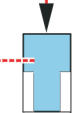
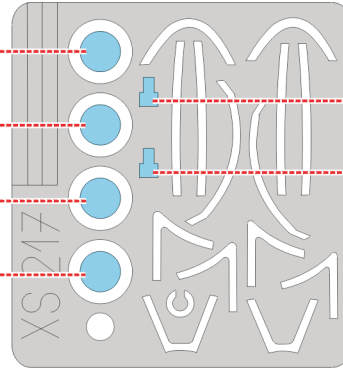
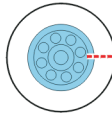

E3
2pcs.

B12
2pcs.

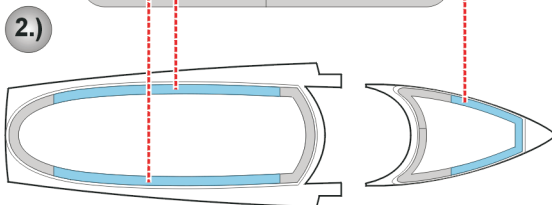
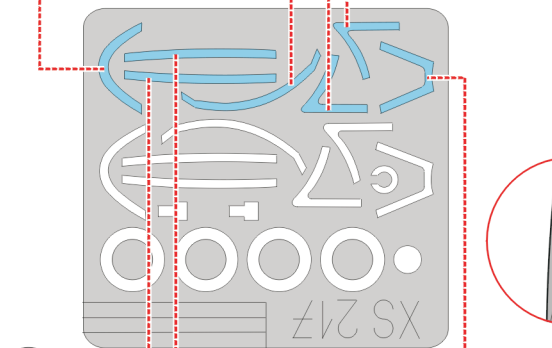
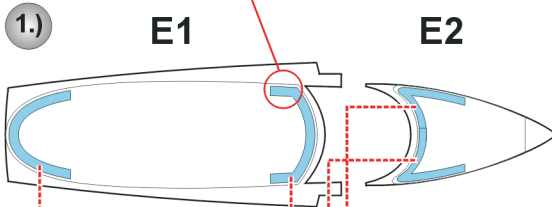
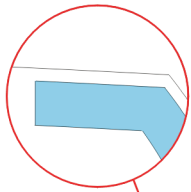
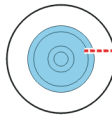

3.)  **INTERIOR COLOR**

4.)  **RUBBER COLOR**

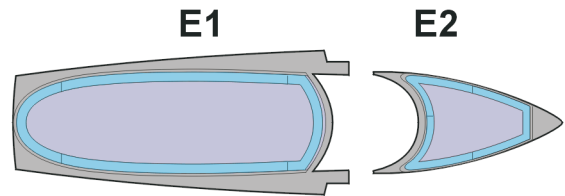

LIQUID MASK ■

5.)  **REMOVE MASK**

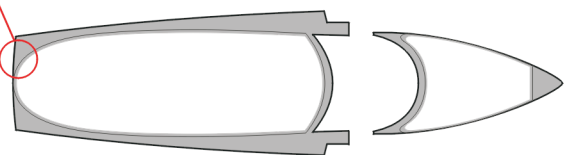

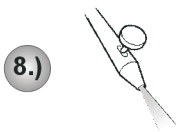
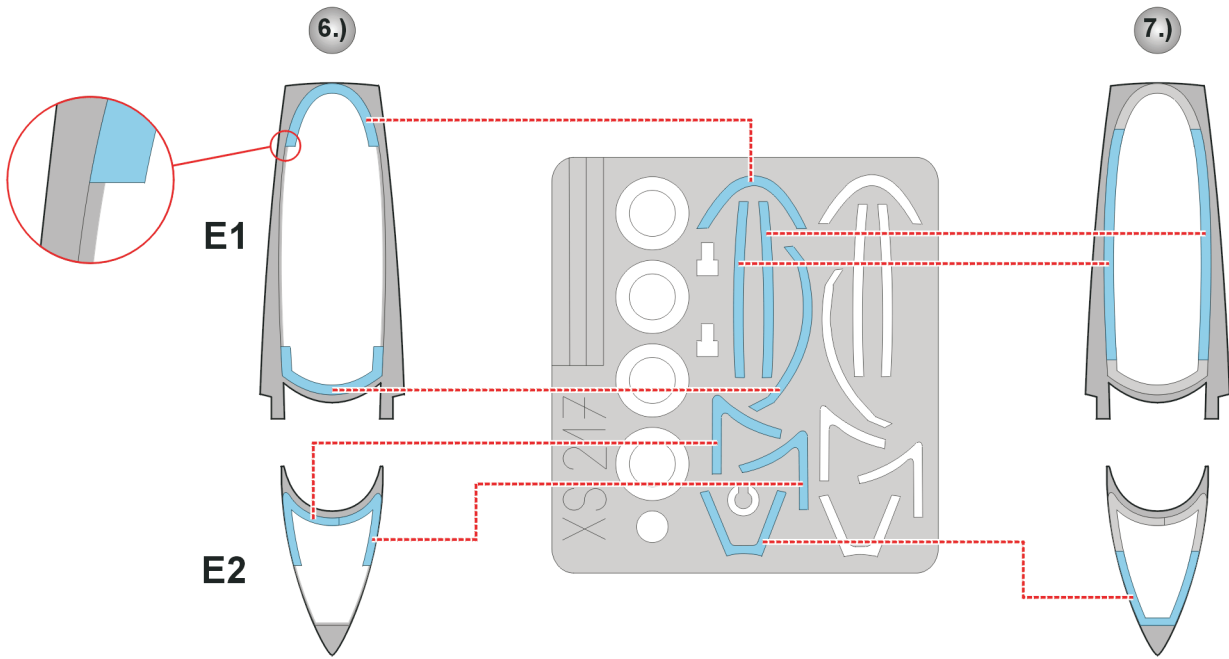

8.)

CAMOUFLAGE COLOR

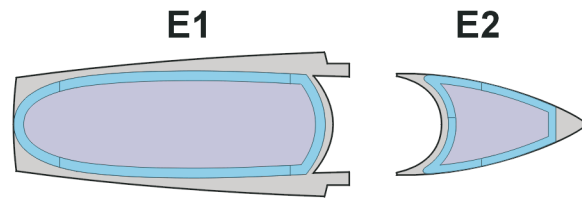

LIQUID MASK ■

9.)

REMOVE MASK

